

ISO 16028/STANDARD



FLAT FACE/STEEL

**Technical data**

- Standard: ISO 16028 (DN06→DN30)
- Occlusion: flat face
- Locking: radial balls
- Material: steel
- Finishing: Zn-Fe (Cr III)
- Threads: BSP-NPT-SAE
- Standard seals: NBR
- Working temperature: -25°C+100°C
- Optional seals: FKM,FFKM,EPDM or more.
- Working pressure: 150-300 bar
- Connection under residual pressure: not allowed



Nominal size				Max working pressure MPa	Rated flow l/min	Max Flow rate l/min	Min burst pressure			Fluid spillage cc
DNP	BG	ISO	mm				Male	Female	Coupled	
06	1	6.3	6	30	12	24	180	120	140	0.008
13	2	10	8.6	25	23	46	160	100	160	0.010
20	3	12.5	10.7	25	45	90	150	110	190	0.012
25	4	19	14.8	25	100	200	140	110	140	0.020
30	5	25	17.6	25	189	280	130	100	140	0.030
35	6	31.5	26	20	260	520	80	110	80	0.040
39	7	38	30	20	379	700	120	110	110	0.050
50	8	51	40.6	15	757	1000	70	65	65	0.100

1 MPa = 145.04 psi • 1 l = 0.264 gal

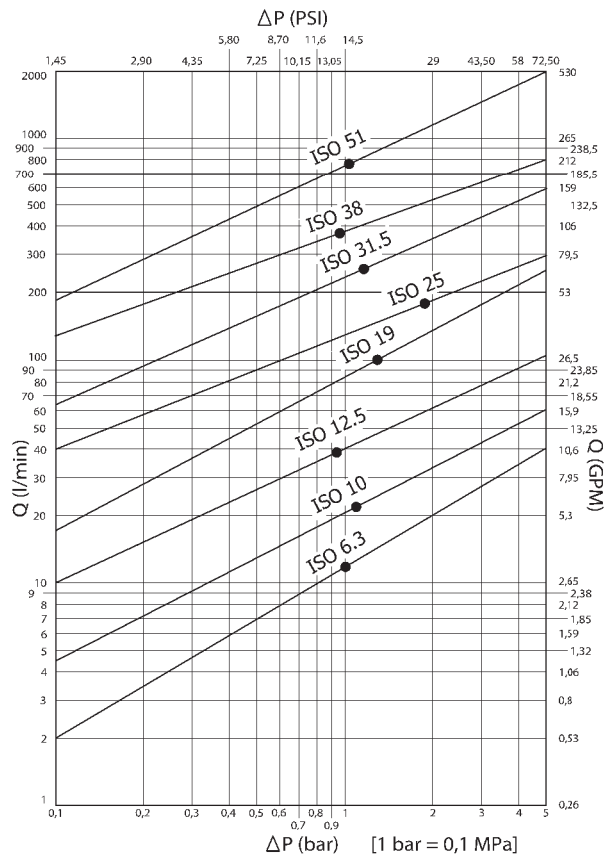

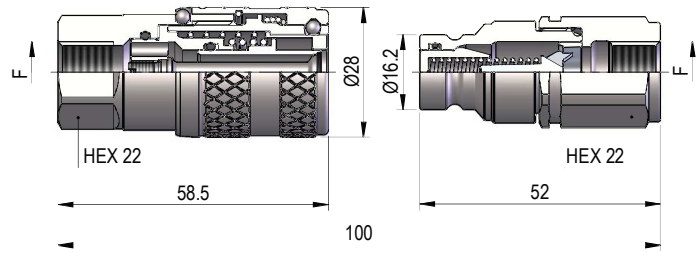
**PLT1 DN06 - BG 1 - ISO 6.3**

THREADS	F	STANDARD	FEMALE			MALE		
			COD. F	Weight (g)	Packaging (pcs)	COD. M	Weight (g)	Packaging (pcs)
IG 1	BSP 1/4"	DIN 3852-2	PLT1.0606.002	181	100	PLT1.0606.003	96	200
	NPT 1/4"	ANSI B1.20.1	PLT1.0606.012	181	100	PLT1.0606.013	96	200

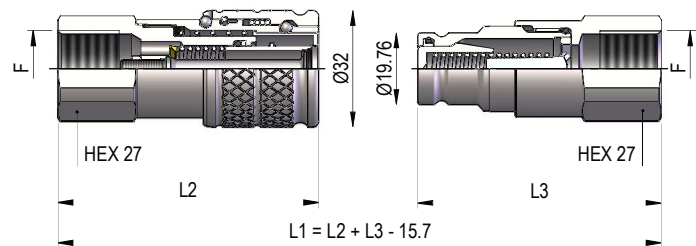
**PLT1 DN13 - BG 2 - ISO 10**

THREADS	L2	L3	F	STANDARD	FEMALE			MALE		
					COD. F	Weight (g)	Packaging (pcs)	COD. M	Weight (g)	Packaging (pcs)
IG 1	67.3	63.5	BSP 3/8"	DIN 3852-2	PLT1.1310.002	256	60	PLT1.1310.003	156	76
			NPT 3/8"	ANSI B1.20.1	PLT1.1310.012	259	60	PLT1.1310.013	159	76
	72.3	67.5	BSP 1/2"	DIN 3852-2	PLT1.1313.002	253	60	PLT1.1313.003	151	76
			NPT 1/2"	ANSI B1.20.1	PLT1.1313.012	256	60	PLT1.1313.013	154	76

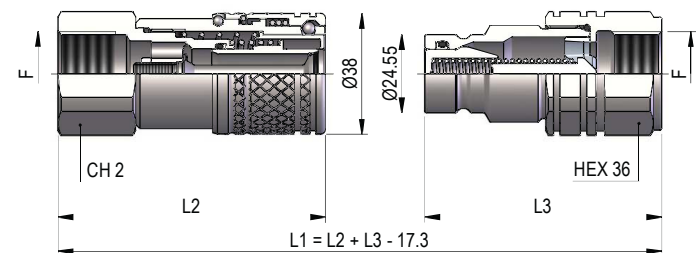
**PLT1 DN20 - BG 3 - ISO 12.5**

THREADS	CH2	L2	L3	F	STANDARD	FEMALE			MALE		
						COD. F	Weight (g)	Packaging (pcs)	COD. M	Weight (g)	Packaging (pcs)
IG 1	32	78.5	72.5	BSP 1/2"	DIN 3852-2	PLT1.2013.002	413	35	PLT1.2013.003	305	42
				NPT 1/2"	ANSI B1.20.1	PLT1.2013.012	408	35	PLT1.2013.013	314	42
	36	84	74.5	BSP 3/4"	DIN 3852-2	PLT1.2019.002	445	35	PLT1.2019.003	282	42
				NPT 3/4"	ANSI B1.20.1	PLT1.2019.012	451	35	PLT1.2019.013	290	42

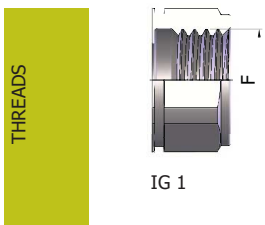

PLT1 DN25 - BG 4 - ISO 19

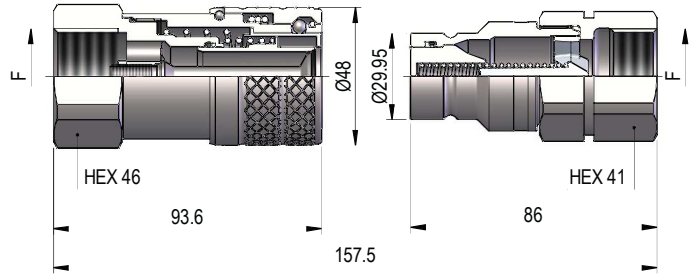

THREADS	F	STANDARD	FEMALE			MALE		
			COD. F	Weight (g)	Packaging (pcs)	COD. M	Weight (g)	Packaging (pcs)
IG 1	BSP 3/4"	DIN 3852-2	PLT1.2519.002	850	23	PLT1.2519.003	478	30
	NPT 3/4"	ANSI B1.20.1	PLT1.2519.012	857	23	PLT1.2519.013	485	30
	BSP 1"	DIN 3852-2	PLT1.2525.002	789	23	PLT1.2525.003	423	30
	NPT 1"	ANSI B1.20.1	PLT1.2525.012	801	23	PLT1.2525.013	435	30

PLT1 DN30 - BG 5 - ISO 25

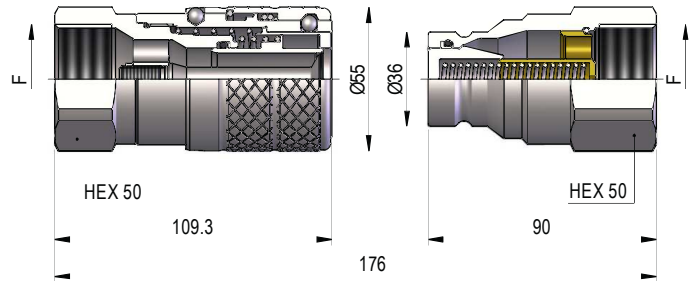

THREADS	F	STANDARD	FEMALE			MALE		
			COD. F	Weight (g)	Packaging (pcs)	COD. M	Weight (g)	Packaging (pcs)
IG 1	BSP 1 1/4"	DIN 3852-2	PLT1.3031.002	1139	7	PLT1.3031.003	648	20
	NPT 1 1/4"	ANSI B1.20.1	PLT1.3031.012	1162	7	PLT1.3031.013	661	20

PLT1 DN35 - BG 6 - ISO 31.5

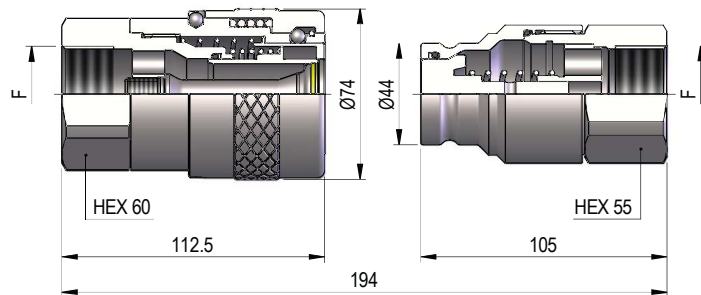

THREADS	F	STANDARD	FEMALE			MALE		
			COD. F	Weight (g)	Packaging (pcs)	COD. M	Weight (g)	Packaging (pcs)
IG 1	BSP 1 1/4"	DIN 3852-2	PLT1.3531.002	2376	5	PLT1.3531.003	1117	10
	NPT 1 1/4"	ANSI B1.20.1	PLT1.3531.012	2400	5	PLT1.3531.013	1130	10
IG 2	1 5/8-12 UN 2B	SAE J 1926-1	PLT1.3541.032	2388	5	PLT1.3541.033	1120	10

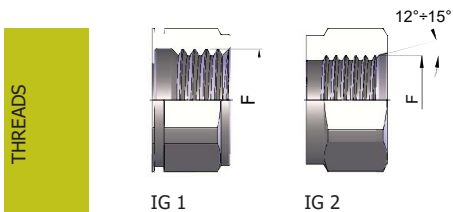

THREADS

IG 1

IG 2

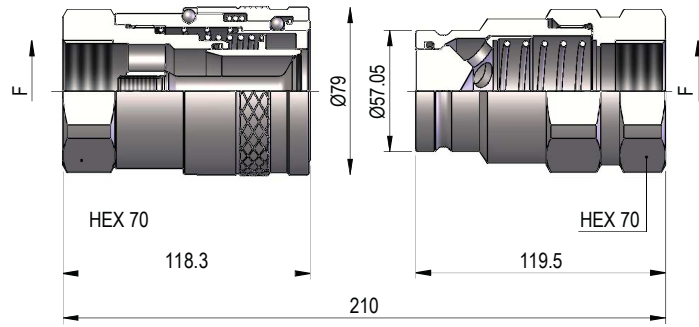
**PLT1 DN39 - BG 7 - ISO 38**

THREADS	F	STANDARD	FEMALE			MALE		
			COD. F	Weight (g)	Packaging (pcs)	COD. M	Weight (g)	Packaging (pcs)
IG 1	BSP 1"½	DIN 3852-2	PLT1.3939.002	2703	5	PLT1.3939.003	1879	10
	NPT 1"½	ANSI B1.20.1	PLT1.3939.012	2718	5	PLT1.3939.013	1893	10
IG 2	1"7/8-12 UN 2B	SAE J 1926-1	PLT1.3947.032	2680	5	PLT1.3947.033	1840	10

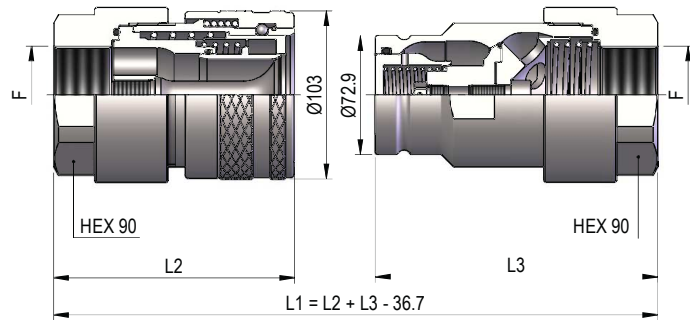
**PLT1 DN50 - BG 8 - ISO 51**

THREADS	L2	L3	F	STANDARD	FEMALE			MALE		
					COD. F	Weight (g)	Packaging (pcs)	COD. M	Weight (g)	Packaging (pcs)
IG 1	147.4	173	BSP 2"	DIN 3852-2	PLT1.5051.112	6015	5	See PLK4 DN50		
			NPT 2"	ANSI B1.20.1	PLT1.5051.012	6045	5	See PLK4 DN50		
IG 2	147.4	173	2"½-12 UN 2B	SAE J 1926-1	PLT1.5063.032	5895	5	See PLK4 DN50		
IG 4	157.4	183	API 2"	API 5B	PLT1.5051.062	6520	5	See PLK4 DN50		

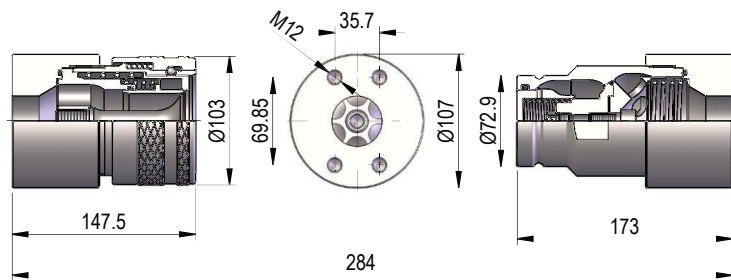

F	STANDARD	FEMALE			MALE		
		COD. F	Weight (g)	Packaging (pcs)	COD. M	Weight (g)	Packaging (pcs)
1"½	SAE 3000	PLT1.5051.002	6440	5	See PLK4 DN50		

THREADS

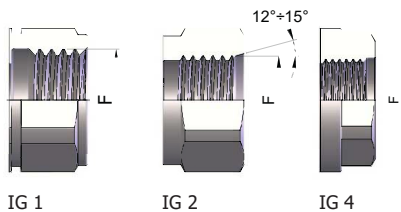

IG 1

IG 2

IG 4

PLASTIC CAPS

NOMINAL SIZE		FEMALE DUST CAP							MALE DUST CAP							COLOR	MATERIAL
DNP	BG	ISO	COD. F	Dimensions			Weight (g)	COD. M	Dimensions			Weight (g)					
				D	L	D1			D	L	D1						
06	1	6.3	SPLT.06002	32.5	200	20	16	SPLT.06003	26	200	20	13	●	PVC			
13	2	10	SPLT.13002	37	200	26	21	SPLT.13003	27.5	200	26	15	●	PVC			
20	3	12.5	SPLT.20002	43	200	31.5	29	SPLT.20003	35	200	31.5	26	●	PVC			
25	4	19	SPLT.25002	53.5	265	35	51	SPLT.25003	43	265	35	41	●	PVC			

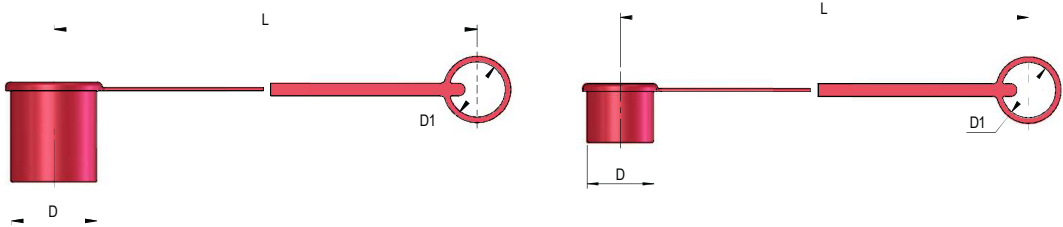

NOMINAL SIZE		FEMALE DUST CAP							MALE DUST CAP							COLOR	MATERIAL
DNP	BG	ISO	COD. F	Dimensions			Weight (g)	COD. M	Dimensions			Weight (g)					
				D	L	D1			D	L	D1						
30	5	25	SPLT.30002	62	280	48	75	SPLT.30003	51	270	48	60	●	PVC			

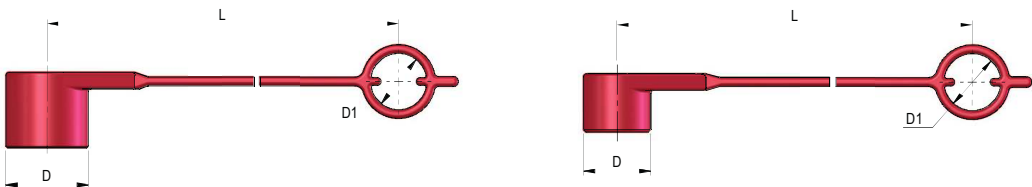

METAL CAPS

NOMINAL SIZE		FEMALE DUST CAP							MALE DUST CAP							MATERIAL
DNP	BG	ISO	COD. F	Dimensions			Weight (g)	COD. M	Dimensions			Weight (g)				
				D	L	D1			D	L	D1					
06	1	6.3	SPLT.06202	35	200	32	41	SPLT.06203	25	200	32	28	Aluminum			
13	2	10	SPLT.13202	40	200	32	48	SPLT.13203	30	200	32	39	Aluminum			
20	3	12.5	SPLT.20202	45	200	32	53	SPLT.20203	32	200	32	40	Aluminum			
25	4	19	SPLT.25202	55	275	47.5	74	SPLT.25203	40	275	47.5	66	Aluminum			
30	5	25	SPLT.30202	65	275	47.5	126	SPLT.30203	45	275	47.5	71	Aluminum			
35	6	31.5	SPLT.35202*	-	-	-	-	SPLT.35203*	-	-	-	-	Aluminum			
39	7	38	SPLT.39202	90	275	47.5	207	SPLT.39203	68	275	47.5	155	Aluminum			
50	8	51	SPLT.50202	114	275	47.5	360	See PLK4 DN50					Aluminum			

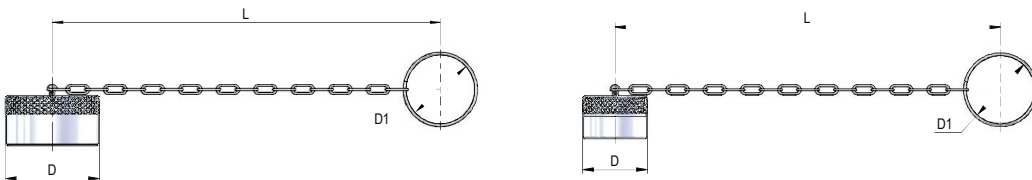

\*AVAILABLE ON REQUEST

AUTOMATIC CAPS

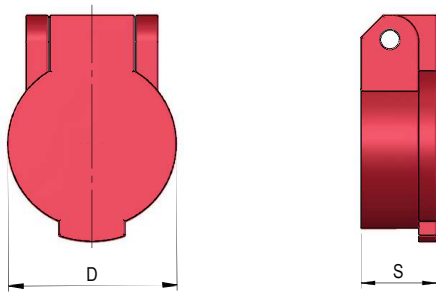

NOMINAL SIZE		AUTOMATIC FEMALE CAP					COLOR	MATERIAL
DNP	BG	ISO	COD. F	Dimensions		Weight (g)		
				D	S			
13	2	10	SPLT.13302	38	17	17		Nylon
13	2	10	SPLT.13342	38	17	17		Nylon
20	3	12.5	SPPV.13302	46	18.5	24		Nylon
20	3	12.5	SPPV.13312	46	18.5	24		Nylon
20	3	12.5	SPPV.13322	46	18.5	24		Nylon
20	3	12.5	SPPV.13332	46	18.5	24		Nylon
20	3	12.5	SPPV.13342	46	18.5	24		Nylon

SPARE PARTS

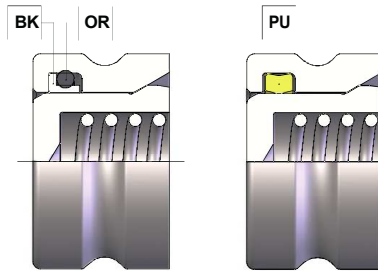

NOMINAL SIZE			MALE GASKET		MALE GASKET
DNP	BG	ISO	OR (NBR*)	BK (PTFE)	PU (POLYURETHANE)
06	1	6.3	PLT.006.120	PLT.006.130	-
13	2	10	PLT.013.120	PLT.013.130	PLK.013.210
20	3	12.5	PLT.019.120	PLT.019.130	PVT.019.210
25	4	19	PLT.025.120	PLT.025.130	PVT.025.210
30	5	25	PLT.031.120	PLT.031.130	PVT.030.210
35	6	31.5	PLS.025.120	PLT.035.130	-
39	7	38	PLT.039.120	PLT.039.130	-
50	8	51	PLK.050.120	PLK.050.130	-

\*TO THE NBR GASKET CODE ADD 'E' FOR EPDM OR 'V' FOR VITON