

All dimensions are imperial unless stated.

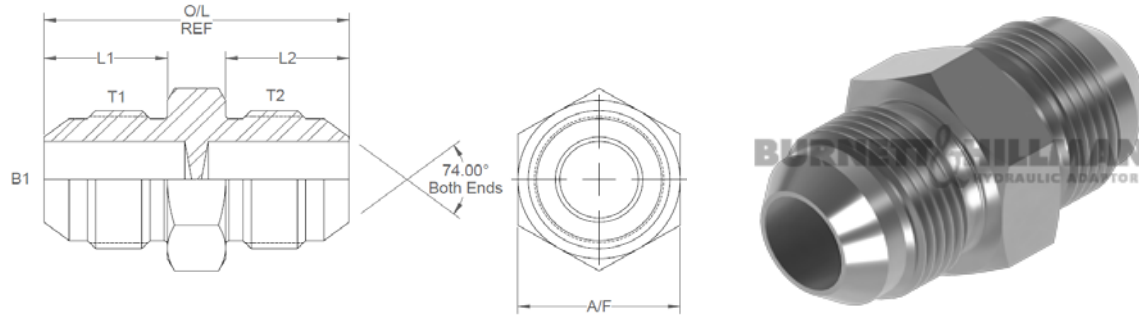

	T1	T2	B1	L1	L2	O/L	A/F
13500	7/16	7/16	0.172	0.55	0.55	1.37	0.5

A/F dimensions are imperial unless stated.

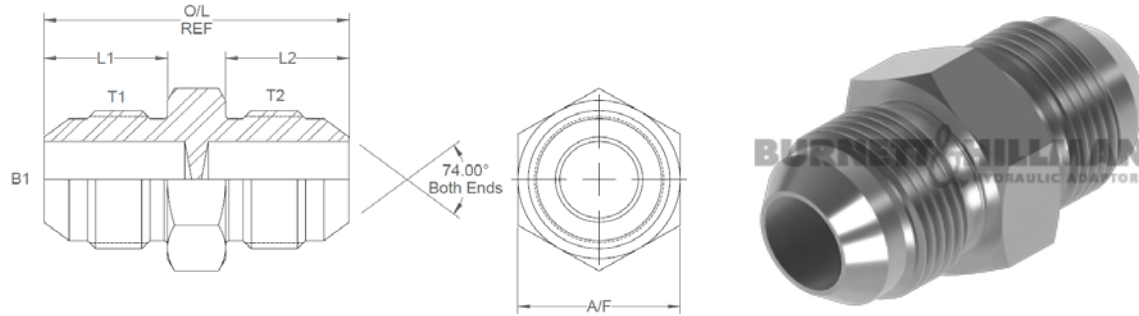

	T1	T2	B1	L1	L2	O/L	A/F
13500	7/16	7/16	4.37	13.97	13.97	34.80	0.5